

- MF 41
- MF 51
- MF 52
- MF 61
- MF 62**
- MF 82
- MF 102

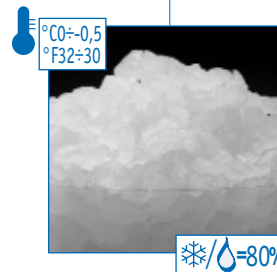

SUPERFLAKE ICE

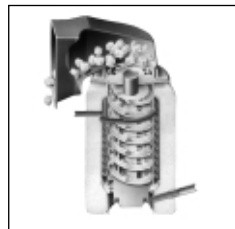
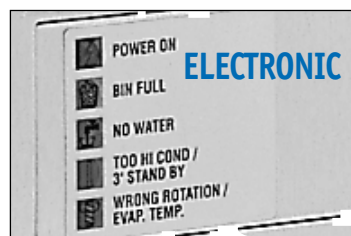

**Split Unit
for Superflake
Ice**

**Unité Split de
Production
de Glace
Supergranulaire**

**Split Produktions-
Einheit für
Superklockeneis**

**Fabricador
Split de
Hielo
Triturado**

**Unità Split
di Produzione
Ghiaccio
Supergranulare**

	24h 10°C / 50°F 10°C / 50°F	[v/Hz/ph]	[HxWxD mm] [HxWxD inches]	R
MF 62 SPLIT	[kg] (lbs) 1200 2640	230/50/1	830 x 535 x 660 32" x 21" x 26"	404 A

2

**Years Warranty
Ans de Garantie
Jahre Garantie
Años de Garantía
Anni di Garanzia**

Subject to certain limitations and exclusions
Assujettie aux limites et exclusions prescrites
Abhängig von Bestimmten Einschränkungen und Ausnahmen
Sumitido a unas limitaciones y exclusiones
Soggetta ad alcune limitazioni ed esclusioni







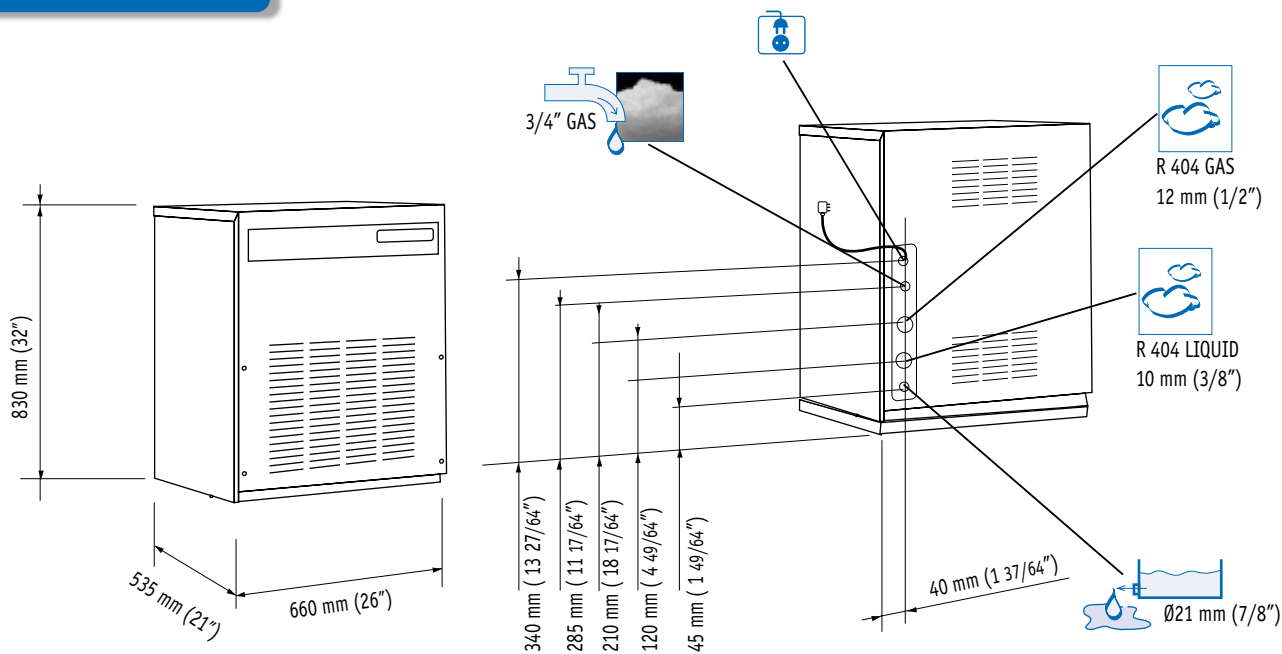

This product qualifies for the following listings:









Models and specifications are subject to change without notice - Les modeles et les caracteristiques des appareils peuvent être changés sans préavis - Wir behalten das Recht vor jederzeit Änderungen der Modelle und der technischen Angaben vorzunehmen. Los modelos y las características pueden ser modificados en cualquier momento y sin aviso - I modelli e le specifiche possono essere cambiate in qualunque momento senza preavviso

MF 62



	 [V/Hz/ph]	 [W]	 [Btu/h]	 [W]	 [A]	 [kg]	 [lbs]	 [kg]	 [lbs]
MF 62 SPLIT	230/50/1	4650	15860	400	1.4	99	218	108	238

 Minimum		 Maximum
10°C (50°F)		40°C (104°F)
5°C (41°F)		35°C (95°F)
-10%		+10%
1 BAR 14 psi		5 BAR 70 psi

Machine requires voltage indicated on rating name plate. Failures caused by improper voltage are not considered factory defects. Scotsman products are not designed for outdoor installation. Extended periods of operation at temperatures exceeding the above limitations constitutes misuse under the terms of Scotsman Limited Warranty, resulting in a loss.

La machine doit être raccordée conformément au voltage indiqué sur la plaque signalétique. Les éventuels dégâts causés par un non respect de cette consigne ne peuvent être considérés comme des défauts de fabrication. Les machines à glace Scotsman ne sont pas conçues pour être utilisées à l'extérieur. Le fonctionnement prolongé à des températures supérieures ou inférieures aux limites ci-dessus sont considérées comme une mauvaise utilisation dans le cadre de la garantie Scotsman.

Der Eisbereiter benötigt eine Stromspannung gemäß Geräte-Typenschild. Störungen oder Ausfälle, durch den Betrieb mit falscher Stromspannung sind keine Fabrikationsfehler und fallen nicht unter Garantie. Scotsman Eisbereiter sind nicht für die Installation im Freien geeignet. Der längere Betrieb bei Temperaturen über den obigen Grenzwerten ist eine falsche Anwendung und bedeutet den Verlust der Garantieleistung.

Los requerimientos eléctricos de la máquina están indicados en la placa de características. Los daños causados por voltajes inadecuados no son considerados defectos de fábrica. La máquinas de hielo Scotsman, no están diseñadas para trabajar a la intemperie. Largos periodos de funcionamiento a temperaturas que excedan de las limitaciones indicadas, constituyen maltrato de acuerdo con las observaciones de Scotsman.

La macchina richiede il voltaggio indicato sulla targhetta di identificazione. Danni causati da voltaggi diversi non sono considerati difetti di produzione. I prodotti Scotsman non vanno utilizzati all'aperto. Un prolungato periodo di utilizzo al di fuori delle temperature indicate non è consentito e causa l'automatico decadere della garanzia.

 **Scotsman**® The one the world relies on.™
Ice Systems

USA, Canada, Central and South America
Scotsman Ice Systems USA
775 Corporate Woods Parkway
Vernon Hills, IL 60061
Ph: (847) 215-4550
Fax (847) 913-9844
E-Mail: customer.service@scotsman-ice.com

Europe, Middle East and Africa
Scotsman Europe - Frimont S.p.A.
Via Puccini, 22
20010 Bettolino di Pogliano (Milano) Italy
Ph: (+39) 02-93960208
Fax: (+39) 02-93960201
E-Mail: scotsman.europe@frimont.it

Asia and Pacific
Scotsman Ice Systems-Frimont S.p.A. (R.O.)
627A Aljunied Road-#04-04 Biztec Centre
Singapore 389842
Ph: (+65) 738 5393-Fax: (+65) 738 1959
E-mail (general): scotsice@singnet.com.sg
E-mail (service): scotserv@singnet.com.sg

China
Scotsman Ice Systems
258 Tong Ren Road Golden Tower 7A
Shanghai - 200040 Peoples' Republic of China
Ph: (+86) 21-62476056
Fax: (+86) 21-62476126
E-mail: scotsmansh@online.sh.cn

South Africa
Scotsman Ice Systems S.A.Pty. Ltd.
69, Audley Road - 2021 Bryanston
P.O. Box 44-2149 Riverclub-South Africa
Ph: +27-11-4636244/5
Fax +27-11-4631411
E-Mail: wooler@freemail.absa.co.za

