

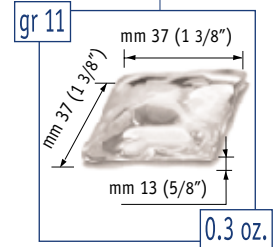

- CME1656
- CME1356
- CME 656
- CME 506
- CME 456
- CM450SL
- SCE 275**

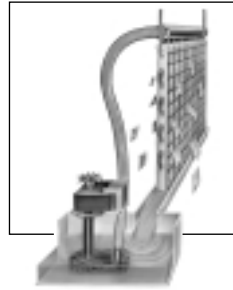

CONTOUR ICE

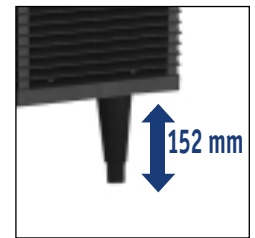
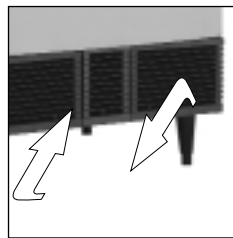

ROTOCAST GRAY PLASTIC

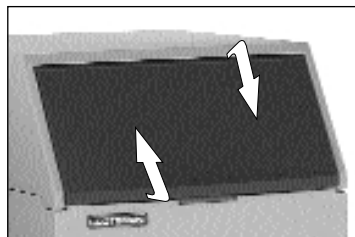

ELECTRONIC CONTROL

**Automatic
Contour
Cube Ice
Machine**

**Machine
Automatique
à Glaçon
Contour**

**Contour
Automatischer
Eisbereiter**

**Máquina
Automática
Fabricadora
de Cubitos
Contour**

**Fabbricatore
Automatico
di Ghiaccio
Contour**

	[kg]	[lbs]	N°	[kg]	[lbs]	N°	[v/Hz/ph]	[HxWxD mm]	[HxWxD inches]		
SCE 275 AE		118	260	10.600	41	90	3700	230/50/1	990 x 762 x 774	39" x 30" x 30"	404 A
SCE 275 WE		125	275	11.300	41	90	3700	230/50/1	990 x 762 x 774	39" x 30" x 30"	404 A

2

**Years Warranty
Ans de Garantie
Jahre Garantie
Años de Garantía
Anni di Garanzia**

Subject to certain limitations and exclusions
Assujettie aux limites et exclusions prescrites
Abhängig von Bestimmten Einschränkungen und Ausnahmen
Sujeta a ciertas limitaciones y exclusiones.
Soggetta ad alcune limitazioni ed esclusioni

This product qualifies for the following listings:



Models and specifications are subject to change without notice - Les modes et les caractéristiques des appareils peuvent être changés sans préavis - Wir behalten das Recht vor jederzeit Änderungen der Modelle und der technischen Angaben vorzunehmen. Los modelos y las características pueden ser modificados en cualquier momento sin previo aviso - I modelli e le specifiche possono essere cambiate in qualunque momento senza preavviso

SCE 275

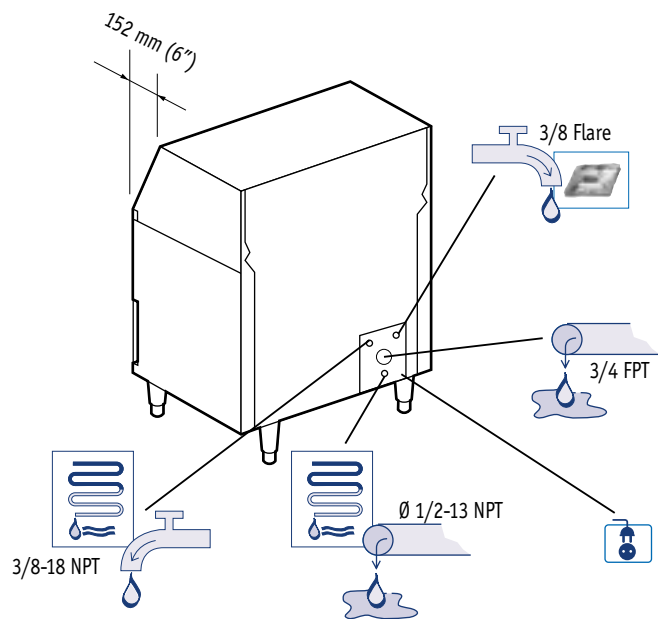
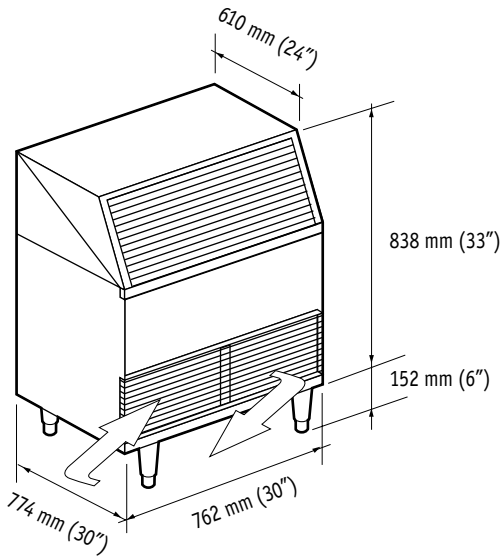

	[C°] [F°]	[Btu/h] [W]	[Ømm ²]	[W]	FUSE	[kWh] 24h	[L/h] [gal/h]	32°C 90°F 21°C 70°F	[kg] [lbs]	[kg] [lbs]	[kg] [lbs]	
SCE 275 AE		5150 1510	3 x 1.5	1080	16 A	20,9	10 2,7		98 215	104 230		
SCE 275 WE		5150 1510	3 x 1.5	1080	16 A	20,7	116 30,8		95 210	102 225		

SCE 275 AIR



°F	90°	70°	60°	50°	
°C	32°	21°	15°	10°	
50°	-	-	-	-	lbs
10°	-	-	-	-	kg
70°	-	-	-	260	lbs
21°	-	-	-	118	kg
90°	-	198	-	-	lbs
32°	-	90	-	-	kg
100	-	-	-	-	lbs
38°	-	-	-	-	kg



Machine requires voltage indicated on rating name plate. Failures caused by improper voltage are not considered factory defects. Scotsman products are not designed for outdoor installation. Extended periods of operation at temperatures exceeding the above limitations constitutes misuse under the terms of Scotsman Limited Warranty, resulting in a loss.

La machine doit être raccordée conformément au voltage indiqué sur la plaque signalétique. Les éventuels dégâts causés par un non respect de cette consigne ne peuvent être considérés comme des défauts de fabrication. Les machines à glace Scotsman ne sont pas conçues pour être utilisées à l'extérieur. Le fonctionnement prolongé à des températures supérieures ou inférieures aux limites ci-dessus sont considérées comme une mauvaise utilisation dans le cadre de la garantie Scotsman.

SCE 275 WATER



°F	90°	70°	60°	50°	
°C	32°	21°	15°	10°	
50°	-	-	-	-	lbs
10°	-	-	-	-	kg
70°	-	-	-	275	lbs
21°	-	-	-	125	kg
90°	-	256	-	-	lbs
32°	-	116	-	-	kg
100	-	-	-	-	lbs
38°	-	-	-	-	kg



Der Eisbereiter benötigt eine Stromspannung gemäß Geräte-Typenschild. Störungen oder Ausfälle, durch den Betrieb mit falscher Stromspannung sind keine Fabrikationsfehler und fallen nicht unter Garantie. Scotsman Eisbereiter sind nicht für die Installation im Freien geeignet. Der längere Betrieb bei Temperaturen über den obigen Grenzwerten ist eine falsche Anwendung und bedeutet den Verlust der Garantieleistung.

Los requerimientos eléctricos de la máquina están indicados en la placa de características. Los daños causados por voltajes inadecuados no son considerados defectos de fábrica. La máquina de hielo Scotsman, no están diseñadas para trabajar a la intemperie. Largos periodos de funcionamiento a temperaturas que excedan de las limitaciones indicadas, constituyen maltrato de acuerdo con las observaciones de Scotsman.

La macchina richiede il voltaggio indicato sulla targhetta di identificazione. Danni causati da voltaggi diversi non sono considerati difetti di produzione. I prodotti Scotsman non vanno utilizzati all'aperto. Un prolungato periodo di utilizzo al di fuori delle temperature indicate non è consentito e causa l'automatico decadere della garanzia.

Minimum		Maximum
10°C (50°F)		40°C (104°F)
5°C (41°F)		35°C (95°F)
-10%		+10%
1 BAR 14 psi		5 BAR 70 psi

Scotsman® The one the world relies on.™
Ice Systems

USA, Canada, Central and South America
Scotsman Ice Systems USA
775 Corporate Woods Parkway
Vernon Hills, IL 60061
Ph: (847) 215-4550 - Fax (847) 913-9844
E-Mail: customer.service@scotsman-ice.com

Europe, Middle East and Africa
Scotsman Europe - Frimont S.p.A.
20010 Bettolino di Pogliano (Milano) Italy
Ph: (+39) 02-93960208
Fax: (+39) 02-93960201
E-Mail: scotsman.europe@frimont.inet.it

Asia and Pacific
Scotsman Ice Systems-Frimont S.p.A. (R.O.)
321 Orchard Road #08-05
Singapore 238866
Ph: (+65) 738 5393 - Fax: (+65) 738 1959
E-mail: scotsice@singnet.com.sg

China
Scotsman Ice Systems
258 Tong Ren Road Golden Tower 7A
Shanghai - 200040 Peoples's Republic of China
Ph: (+86) 21-62476056-Fax: (+86) 21-62476126
E-mail: scotsmansh@online.sh.cn

